

IPSC30 - Pressure sequence valve

Poppet, direct acting, normally closed, internal pilot, external drain, reverse flow check
 30 L/min (8 USgpm) • 350 bar (5000 psi)

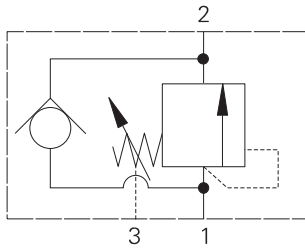

Operation

As with the direct acting relief valves, when the pressure exceeds the spring force, the spool moves back, opening the inlet to outlet.

Features

Match ground and honed hardened working parts give long, trouble-free life. Consistent stable operation providing low pressure rise due to increasing flow.

Cartridge construction gives maximum flexibility in mounting. Steel valve bodies available on request.

Sectional view

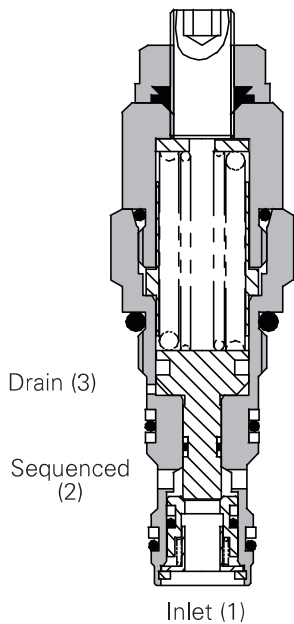

Performance data

Ratings and specifications

Figures based on: Oil Temp = 40° C Viscosity = 32 cSt (150 SUS)

Rated flow	30 L/min (8 USgpm)
Max setting	350 bar (5000 psi)
Cartridge material	Working parts hardened and ground steel. External steel surfaces zinc plated.
Body material	Standard aluminium (up to 210 bar*). Add suffix "377" for steel.
Mounting position	Unrestricted
Cavity number	A6610 (See Section M)
Torque cartridge into cavity	45 Nm (33 lbs ft)
Weight	PSC30 0.15 kg (0.33 lbs) PSC35 0.41 kg (0.90 lbs)
Seal kit number	SK395 (Nitrile) SK395V (Viton®)
Recommended filtration level	BS5540/4 Class 18/13 (25 micron nominal)
Operating temp	-30°C to +90°C (-22°C to 194°F)
Leakage	0.3 milliliters/min nominal (5 dpm)
Nominal viscosity range	5 to 500 cSt

Viton is a registered trademark of E.I. DuPont

Description

Sequence valves provide ordered sequencing of two or more operations as with clamp and drill circuits. They can also be used as relief valves where the downstream pressure is high or changes during operation. By taking the drain line directly to tank, back pressure effects are negated.

Pressure drop curves

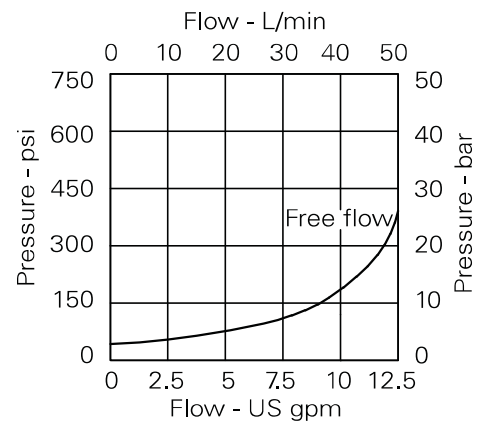
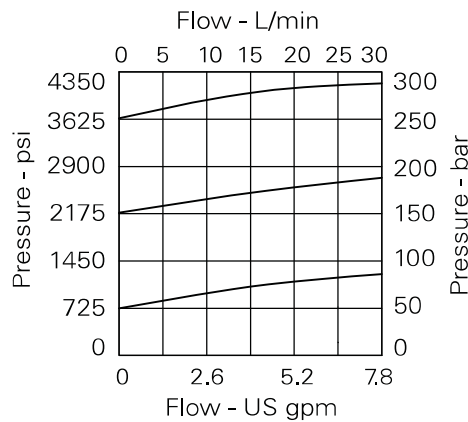

Where measurements are critical request certified drawings. We reserve the right to change specifications without notice.

IPSC30 - Pressure sequence valve

Poppet, direct acting, normally closed, internal pilot, external drain, reverse flow check
30 L/min (8 USgpm) • 350 bar (5000 psi)

Model code

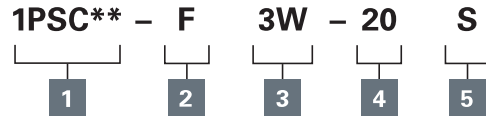

1 Function

1PSC30 - Cartridge Only
1PSC30 - Cartridge and body

2 Adjustment means

F - Screw adjustment
N - Fixed - State pressure
Setting required

3 Port sizes

Code	Port size	Housing number - body only	
		Aluminium	Steel
3W	3/8" BSP Valve & Cyl Port. 1/4" BSP Pilot Port	B6743	B12823
6T	3/8" SAE Valve & Cyl Port. 1/4" SAE Pilot Port	B10536	
8T	1/2" SAE Valve & Cyl Port. 1/4" SAE Pilot Port	B7884	B11811

4 Pressure Range @ 4,8 L/min

Note: Code based on pressure in bar.
10 - 10–100 bar.
Std setting 70 bar
20 - 60–210 bar.
Std setting 100 bar
35 - 70–350 bar.
Std setting 210 bar

5 Seals

S - Nitrile (For use with most industrial hydraulic oils)
SV - Viton (For high temperature and most special fluid applications)

Dimensions

mm (inch)

Cartridge only

Basic Code
1PSC30

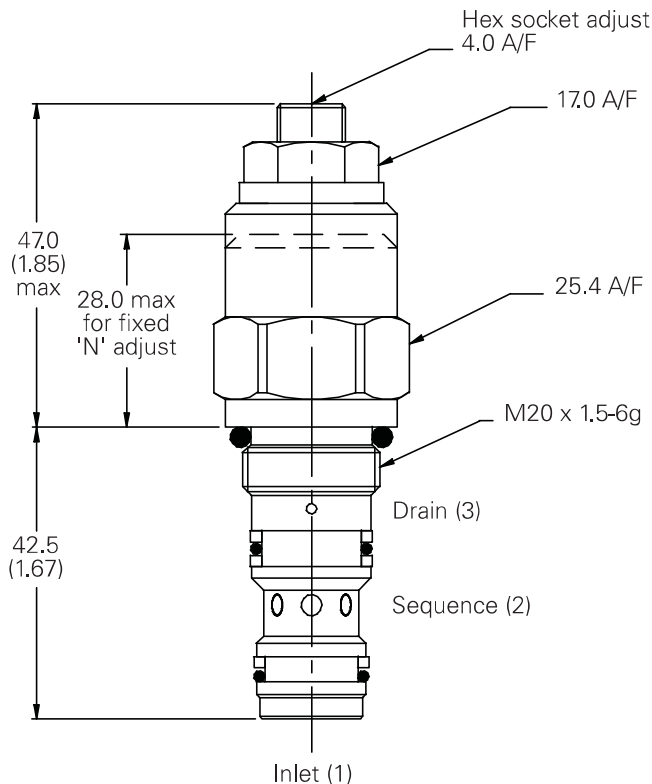

Complete valve

3/8", 1/2" Ports
Basic Code
1PSC35

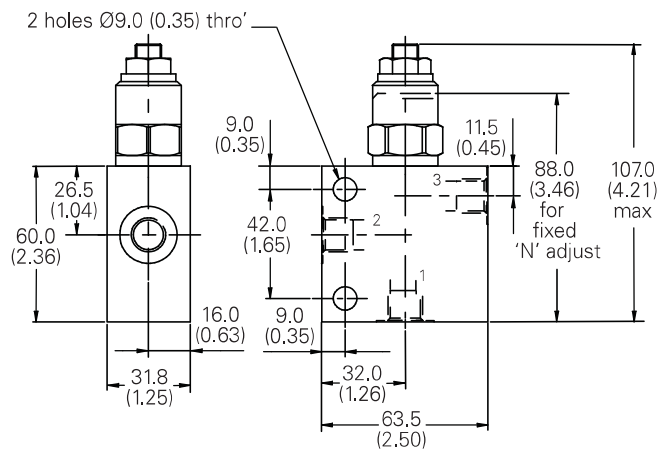

Note: Tightening torque of "F" adjuster locknut - 20 to 25 Nm.

Note: For applications above 210 bar please consult our technical department or use the steel body option.

Where measurements are critical request certified drawings. We reserve the right to change specifications without notice.