

1VR200 - Relief valve

Spool, ventable, pilot operated
200 L/min (52 USgpm) • 350 bar (5000 psi)

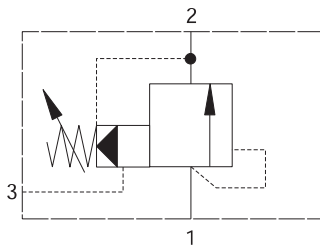

Operation

When inlet pressure exceeds the setting of the valve, the pilot section opens. The pilot flow causes a pressure imbalance across the main section spool causing it to open, allowing relief flow to tank.

When 'vented', pilot flow is referenced directly to tank, bypassing the pilot section. This flow through the vent causes a pressure imbalance, opening the main section and dumping the pump at minimum pressure drop.

Features

High accuracy of pilot operated design. Hardened working parts give long, reliable, trouble-free life. Ventable for versatility of application. Cartridge construction for installation into your own manifold.

Sectional view

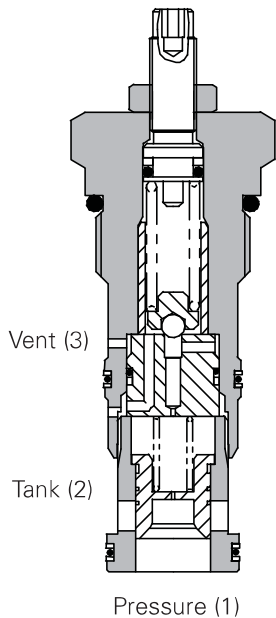

Performance data

Ratings and specifications

Figures based on: Oil Temp = 40°C Viscosity = 32 cSt (150 SUS)

Rated flow	200 L/min (52 USgpm)	
Max setting	350 bar (5000 psi)	
Cartridge material	Working parts hardened and ground steel. External surfaces zinc plated.	
Body material	Standard aluminium (up to 210 bar). Add suffix "377" for steel option.	
Mounting position	Unrestricted	
Cavity	A16102 (See Section M)	
Torque cartridge into cavity	100 Nm (73 lbs ft)	
Weight	1VR200	0.74 kg (1.6 lbs)
	1VR250	1.82 kg (4.0 lbs)
Seal Kit	SK173 (Nitrile) SK173V (Viton®)	
Recommended filtration level	BS5540/4 Class 18/13 (25 micron nominal)	
Operating temp	-30° to +90°C (-22° to +194°F)	
Leakage	35 milliliters/min @ 280 bar	
Nominal viscosity range	5 to 500 cSt	

Viton is a registered trademark of E.I. DuPont

Description

This is a ventable, internally pilot operated relief valve designed to limit pressure in a system. Good for continuous duty and accurate pressure control with constant or varying flows. The vent feature can be used with remote pilot section for a two-pressure system or to allow manual or remote 'unloading' of the pump.

Pressure drop curves

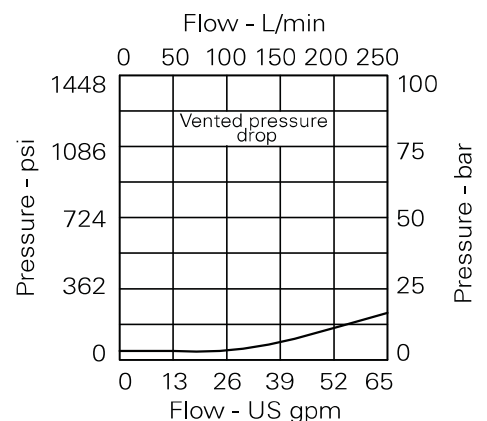
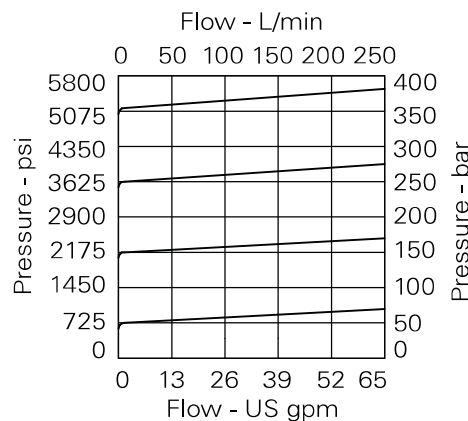

Where measurements are critical request certified drawings. We reserve the right to change specifications without notice.

1VR200 - Relief valve

Spool, ventable, pilot operated
200 L/min (52 USgpm) • 350 bar (5000 psi)

Model code

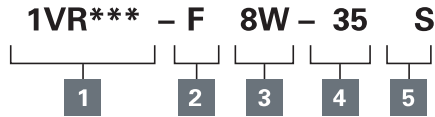

1 Function

1VR200 - Cartridge Only
1VR250 - Cartridge and Body

2 Adjustment means

P - Leakproof Screw Adjustment
G - Tamperproof Cap
(See page E-7 for dimensions)

3 Port size

Code	Port size	Housing number - body only	
		Aluminium	Steel
8W	1" BSP	B3496	B3497
16T	1" SAE	B6807	B11555

4 Pressure range @ 14 l/min

Note: Code based on pressure in bar.
20 - 10-210 bar, Std setting 100 bar
35 - 30-350 bar, Std setting 210 bar
Std setting made at 14 L/min

5 Seals

S - Nitrile (For use with most industrial hydraulic oils)
SV - Viton (For high temperature and most special fluid applications)

Dimensions

mm (inch)

Cartridge only

Basic Code
1VR200

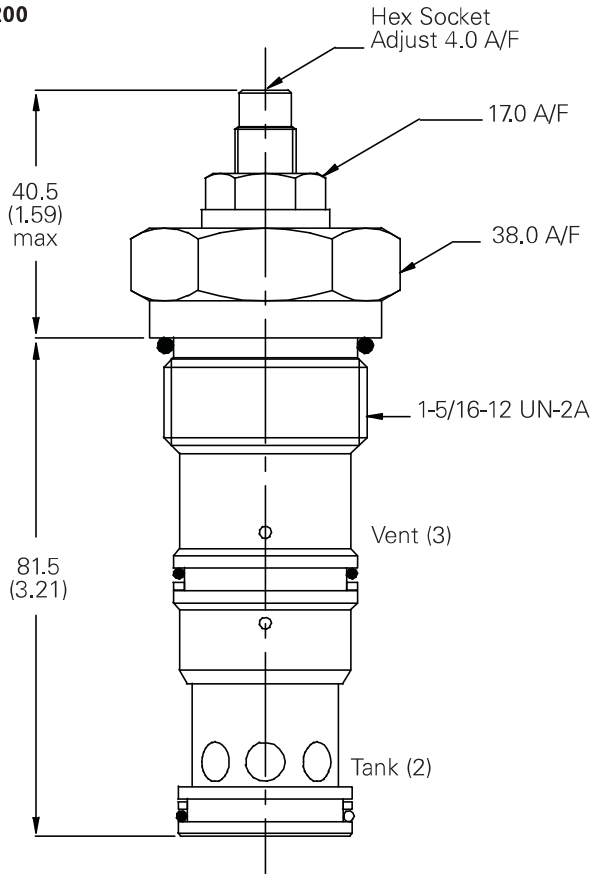

Complete valve

3/4" Ports
Basic Code
1VR250

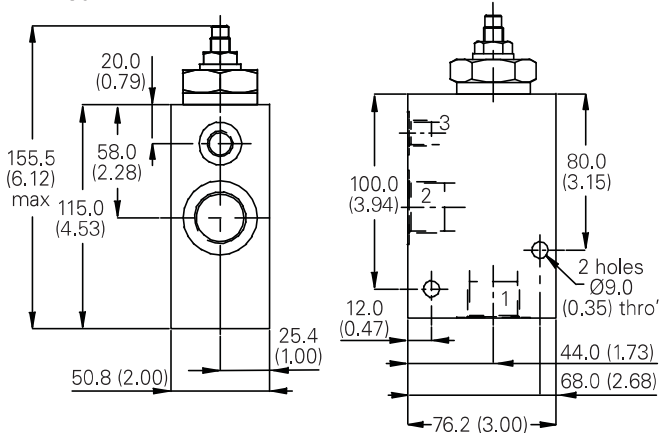

Note: For applications above 210 bar, please consult our technical department or use the steel body option.

Note: Tightening torque of "F" adjuster locknut - 20 to 25 Nm.

Where measurements are critical request certified drawings. We reserve the right to change specifications without notice.