

2FPH - Flow regulator

Pressure compensated regulator/diverter, priority style. solenoid switch
Up to 160 L/min (42 USgpm) • 350 bar (5000 psi)

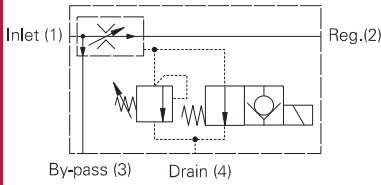

Operation

Inlet flow passes through the adjustable orifice and the radial holes in the spool/sleeve assembly then out of the regulated port. The pressure drop across the orifice is sensed at each end of the spool, producing a force which, at the required flow rate, overcomes the spring force. The resultant movement of the spool regulates the flow by opening the radial valve ports to the bypass port and closing the regulated

flow ports. The solenoid valve vents the spring chamber to a drain line and in its NORMAL (de-energized) mode all inlet flow is diverted to the bypass port. The pre-set regulated flow is selected by energizing the solenoid. The adjustable relief valve vents the spring chamber at the pre-set pressure and diverts the flow to the bypass port. It may be necessary to fit a 10 bar check valve in the bypass or regulated line to ensure the valve switches fully.

Features

Line body construction with three ports allows direct connection into hydraulic systems. Leakproof adjust screw gives easy, accurate adjustment to required flow setting. Remote functional selection with solenoid operation. Adjustable relief valve gives system protection. Hardened and ground working parts give accurate flow control and long working life.

Sectional view

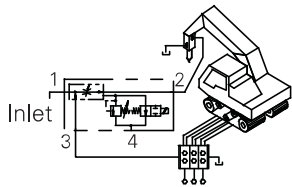
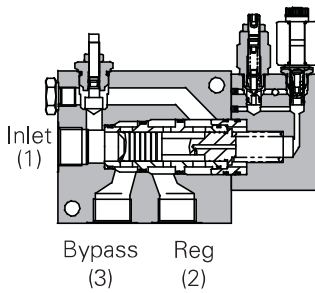

Performance data

Ratings and specifications

Figures based on oil temperature of 40° C and of 32 cSt (150 SUS)

Rated flow	Inlet	2FPH55	95 L/min (25 USgpm)
		2FPH95	150 L/min (40 USgpm)
Regulated	Regulated	2FPH195	380 L/min (100 USgpm)
		2FPH55	55 L/min (14 USgpm)
		2FPH95	95 L/min (25 USgpm)
Maximum pressure	2FPH55	280 bar (4000 psi)	
	2FPH95/2FPH195	350 bar (5000 psi)	
Material	All working parts hardened & ground steel		
Standard housing material	2FPH55	Aluminum (up to 210 bar)	
	2FPH95/2FPH195	Steel	
Mounting position	Line mounted		
Weight	2FPH55	3.00 Kg (6.60 lbs)	
	2FPH95	3.50 Kg (7.70 lbs)	
	2FPH195	12.26 Kg (27.00 lbs)	
Seal kit number	2FPH55	SK267 (Nitrile) SK267V (Viton)	
	2FPH95	SK547 (Nitrile) SK547V (Viton)	
	2FPH195	SK258 (Nitrile) SK258V (Viton)	
Recommended filtration level	BS5540/4 Class 18/13 (25 micron nominal)		
Operating temperature	-30° to +90°C (-22° to +194°F)		
Nominal range	5 to 500 cSt		

Viton is a registered trademark of E.I. DuPont

Description

The 2FPH series of priority flow regulator valves gives full control of regulated flow plus remote selection of priority flow and adjustable pressure limitation of the regulated line.

Pressure drop

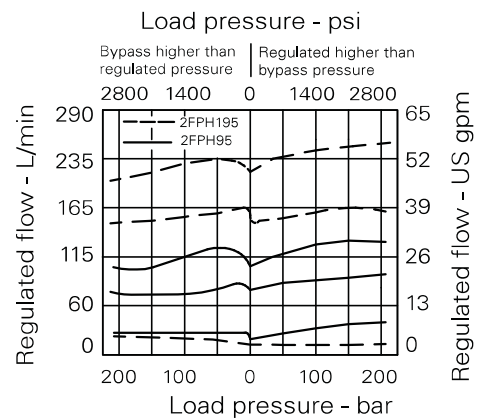
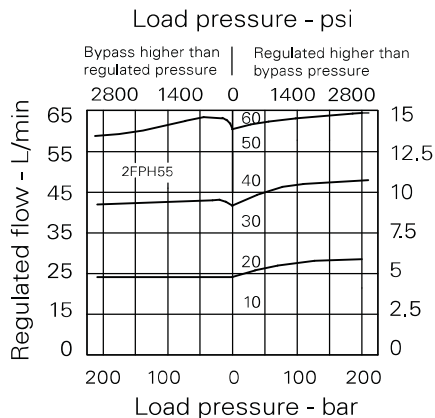

Where measurements are critical request certified drawings. We reserve the right to change specifications without notice.

2FPH - Flow regulator

Pressure compensated regulator/diverter, priority style, solenoid switch
Up to 160 L/min (42 USgpm) • 350 bar (5000 psi)

Model code

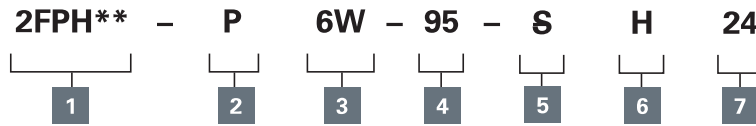

1 Basic code

2FPH55 - Complete valve
2FPH95 - Complete valve
2FPH195 - Complete valve

2 Adjustment means

P - Leakproof screw adjustment
R - Handknob adjustment (See page H-6 for dimensions)

3 Port size - bodied valves only

4W - 1/2" BSP
6W - 3/4" BSP
8W - 1" BSP
8T - 1/2" SAE
12T - 3/4" SAE
16T - 1" SAE

4 Adjustable flow range

2FPH55 - 0-55 liters/min
2FPH95 - 0-95 liters/min
2FPH195 - 0-195 liters/min

5 Seals

S - Nitrile (for use with most industrial hydraulic oils)
SV - Viton (for high temperature & most special fluid applications)

6 Coil termination

H - ISO 4400 (plug included)
F - Flying leads, DC only
DM - Deutsch moulded
Other terminations available on request

7 Voltage

12 - 12 VDC
24 - 24 VDC
Other options available on request

Code	Port size	A	B	C	D	E	F	G	H	K	L	M	N	O	P	Std R/V
2FPH55	1/2"	168	51	76	127	44.5	82.5	-	32	28.5	8.5	10	95	Ø8.5	SX203	280 bar
2FPH95	3/4"	232	63.5	76	127	58	102	58	39.5	32	10	10	136	Ø10.5	S207	200 bar
2FPH195	1"	227.5	63.5	133	168	47	104	108	32	67	13	13	127	Ø13.5	S207	280 bar

Dimensions

mm (inch)

Complete valve

Basic code
2FPH

Note: For applications above 210 bar please consult our technical department or use the steel body option

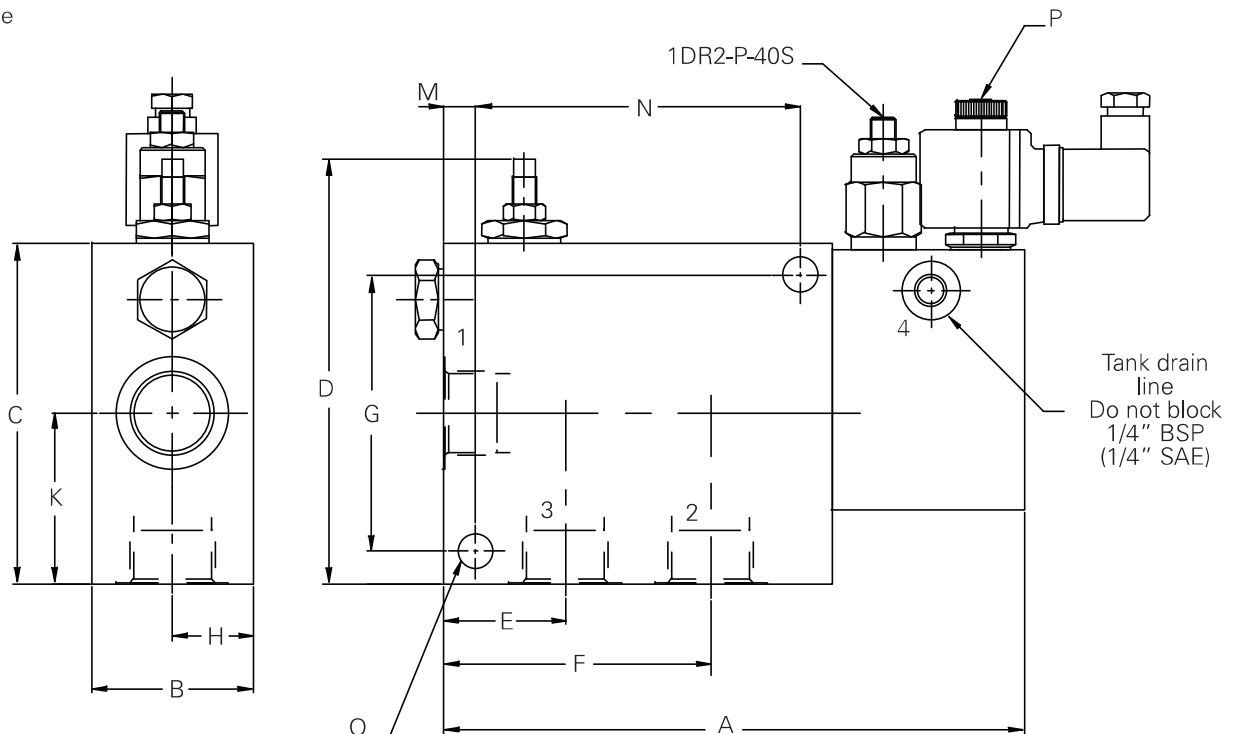

Where measurements are critical request certified drawings. We reserve the right to change specifications without notice.

2FPH - Flow regulator

Pressure compensated regulator/diverter, priority style. solenoid switch
 350 L/min (92 USgpm) • 350 bar (5000 psi)

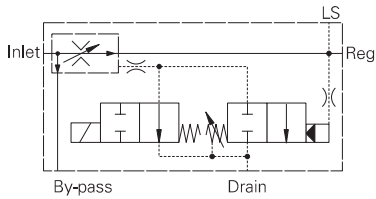

Operation

Inlet flow passes through the adjustable orifice and the radial holes in the spool/sleeve assembly then out of the regulated port. The pressure drop across the orifice is sensed at each end of the spool, producing a force which, at the required flow rate, overcomes the spring force. The resultant movement of the spool regulates the flow by opening more radial holes to the bypass port. The solenoid valve vents the spring chamber to a drain line

and in its de-energized mode all inlet flow is diverted to the bypass port. The pre-set regulated flow is selected by energizing the solenoid. The adjustable pilot valve vents the spring chamber when the regulated line reaches the preset pressure, diverting the flow to the bypass port where the pressure can continue to rise if necessary. It may be necessary to fit a 10 bar check valve in the bypass or regulated line to ensure the valve switches fully.

Features

Line body construction with three ports allows direct connection into hydraulic systems. Leakproof adjust screw gives easy, accurate adjustment to required flow setting. Remote functional selection with solenoid operation. Adjustable relief valve gives system protection whilst allowing bypass pressure to rise above setting if required. Hardened and ground working parts give accurate flow control and long working life.

Performance data

Ratings and specifications

Figures based on oil temperature of 40° C and of 32 cSt (150 SUS)

Rated flow	Inlet	2FPH250	350 L/min (92 USgpm)
		2FPH350	450 L/min (120 USgpm)
	Regulated	2FPH250	200 L/min (52 USgpm)
		2FPH350	350 L/min (92 USgpm)
Maximum pressure			350 bar (5000 psi)
Material			All working parts hardened & ground steel
Standard housing material			Steel, zinc plated and passivated
Mounting position			Line mounted
Weight		2FPH250	17 kg (37.4 lbs)
		2FPH350	28 kg (61.0 lbs)
Seal kit number	2FPH250	SK819 (Nitrile), SK819V (Viton®)	
	2FPH350	SK820 (Nitrile), SK820V (Viton®)	
Recommended filtration level	BS5540/4	Class 18/13 (25 micron nominal)	
Operating temperature		-30° to +90° C (-22° to +194° F)	
Nominal range		5 to 500 cSt	

Viton is a registered trademark of E.I. DuPont

Description

The 2FPH series of priority flow regulator valves gives full control of regulated flow plus remote selection of priority flow and adjustable pressure limitation of the regulated line.

Pressure drop

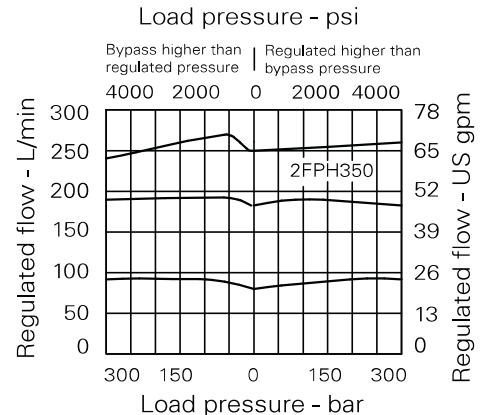
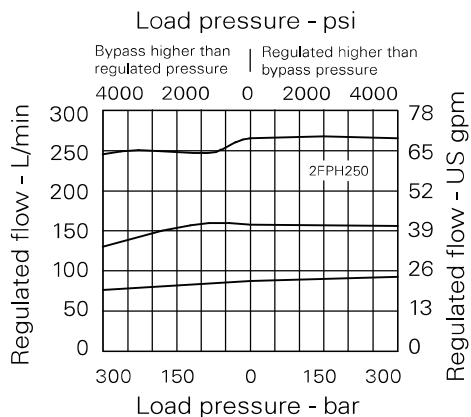

Where measurements are critical request certified drawings. We reserve the right to change specifications without notice.

2FPH - Flow regulator

Pressure compensated regulator/diverter, priority style, solenoid switch
350 L/min (92 USgpm) • 350 bar (5000 psi)

Model code

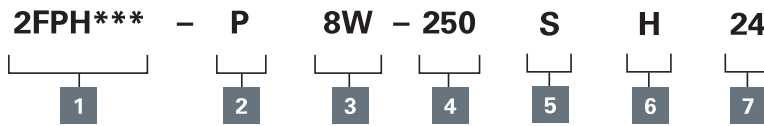

1 Basic code

2FPH250 - Complete valve
2FPH350 - Complete valve

2 Adjustment means

PR

3 Port size - bodied valves only

8W - 1" BSP
12W - 1 1/2" BSP
16T - 1" SAE
24T - 1 1/2" SAE

4 Adjustable flow range

250 - 0-250 L/min (2FPH250)
350 - 0-350 L/min (2FPH350)

5 Seals

S - Nitrile (for use with most industrial hydraulic oils)
SV - Viton (for high temperature & most special fluid applications)

6 Coil termination

H - ISO 4400 (plug included)
F - Flying leads, DC only
DM - Deutsch moulded other terminations available on request

7 Voltage

12 - 12 VDC
24 - 24 VDC
Other options available on request

Basic code	port size	A	B	C	D	E	F	G	H	K	L	M	N	O	P	O	R	S	Std R/V
2FPH250	1"	177	63.5	177.8	75	70	31.75	143	47.5	105	15	62	110	95	63	13.5	-	-	280 bar
2FPH350	1-1/2"	269	76.2	177.8	75	70	38.1	100	89	164	5	62	15	100	39	18	90	50	200 bar

Dimensions

mm (inch)

Complete Valve

Basic code
2FPH

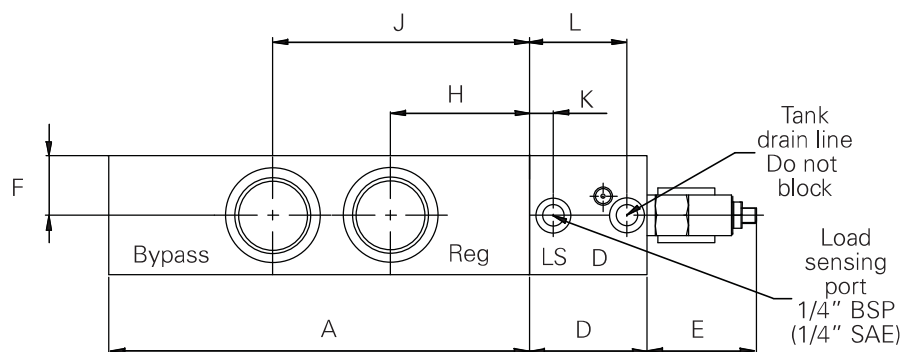
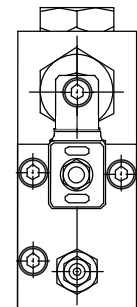
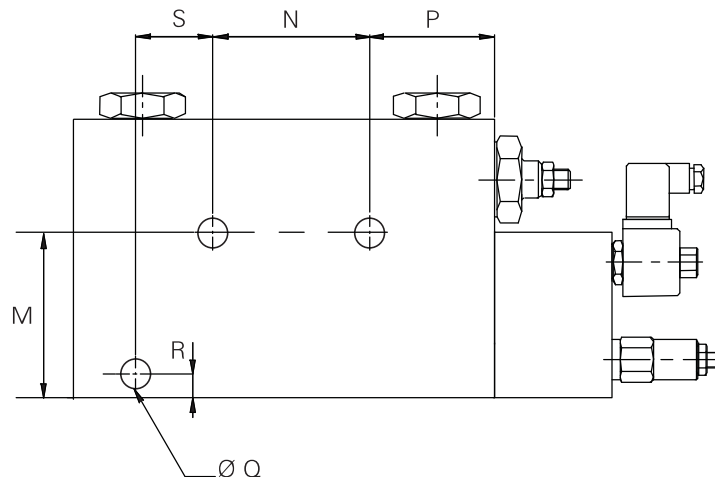
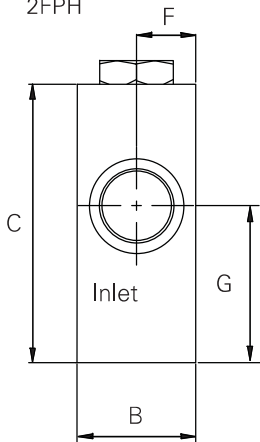

Where measurements are critical request certified drawings. We reserve the right to change specifications without notice.