

4CKKT - Check valve

Dual, pilot-to-open with thermal relief
 25 L/min (6.6 USgpm) • 300 bar (4350 psi)

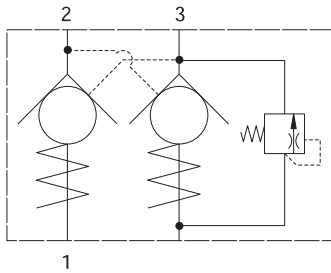

Operation

Pressure on the valve port causes the poppet to lift against the spring force, allowing the flow to the cylinder port. Reverse flow is prevented by the poppet reseating. Pressure applied to the pilot port will overcome the cylinder port pressure and lift the poppet from its seat, allowing flow from the cylinder to valve port.

In dual pilot check valves, each pilot section is cross connected to the opposite line giving automatic pilot operation in both directions. When the pressure in C2 rises above the setting of the relief valve, the relief valve will open, allowing flow to the V2 port, relieving pressure on the cylinder.

Features

Hardened and ground poppet gives excellent flow capability for valve size, positive sealing and long working life. Cartridge construction allows installation in actuators, manifold blocks and Hydraulic Integrated Circuits.

Sectional view

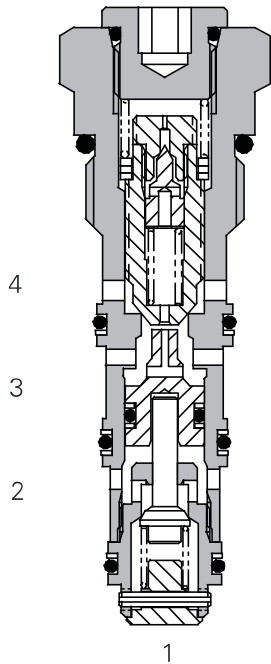

Performance data

Ratings and specifications

Figures based on oil temperature of 40° C and viscosity of 32 cSt (150 SUS)

Rated flow	25 L/min (6.6 USgpm)
Maximum pressure	300 bar (4350 psi)
Pilot ratio	3:1
Cartridge material	Working parts hardened and ground steel. Electroless zinc plated body.
Standard housing material	Standard aluminum (up to 210 bar). Add suffix "377" for steel option.
Mounting position	Unrestricted
Cavity number	A12744 (See Section M)
Torque cartridge into cavity	30 Nm (22 lbs. ft.)
Weight	4CKKT50 0.08 kg (0.18 lbs) 4CKKT55 0.34 kg (0.75 lbs)
Seal kit number	SK1120 (Nitrile) SK1120V (Viton®)
Recommended filtration level	BS5540/4 Class 18/13 (25 micron nominal)
Operating temperature	-30° to +90° C (-22° to +194°F)
Leakage	C1 - V1 1.0 ml/min nominal (15 dpm) C2 - V2 0.3 ml/min nominal (5 dpm)
Nominal viscosity range	5 to 500 cSt

Viton is a registered trademark of E. I. DuPont

Description

Pilot check valves allow flow to pass in one direction, with a low pressure drop, then prevent reverse flow until pilot pressure is applied. There are many applications for this valve type, the most common being to lock and hold a cylinder, or another hydraulic actuator, in position.

A pilot relief valve will protect the cylinder and hoses from thermal expansion of the hydraulic fluid. The maximum flow through the relief is 1.0l/min.

Pressure drop

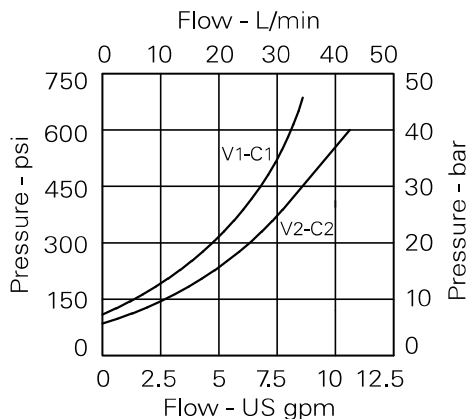

Free flow

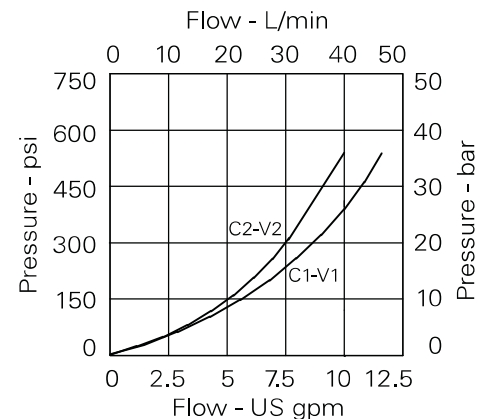

Piloted open

Where measurements are critical request certified drawings. We reserve the right to change specifications without notice.

4CKKT - Check valve

Dual, pilot-to-open with thermal relief
25 L/min (6.6 USgpm) • 300 bar (4350 psi)

Model code

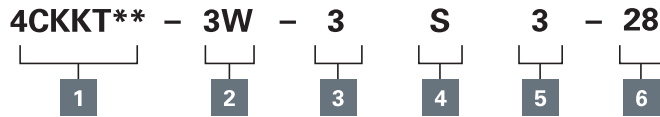

1 Basic code

4CKKT50 - Cartridge only
4CKKT55 - Cartridge and body

2 Port size - bodied valves only

Code	Port size	Housing number
Aluminium dual		
3W	3/8" BSP	B19240
6T	3/8" SAE	B19241
4W	1/2" BSP	B19228
8T	1/2" SAE	B19229

3 Pilot Ratio

3 - 3:1

4 Seals

S - Nitrile (For use with most industrial hydraulic oils)
SV - Viton (For high temperature and most special fluid applications)

5 Optional Pilot Seal

3 - Standard
Omit if not required

6 Pressure Setting

24 - 240 bar (3500 psi)
28 - 280 bar (4000 psi)
35 - 350 bar (5000 psi)

Description

mm (inch)

Cartridge only

Basic code
4CKKT50

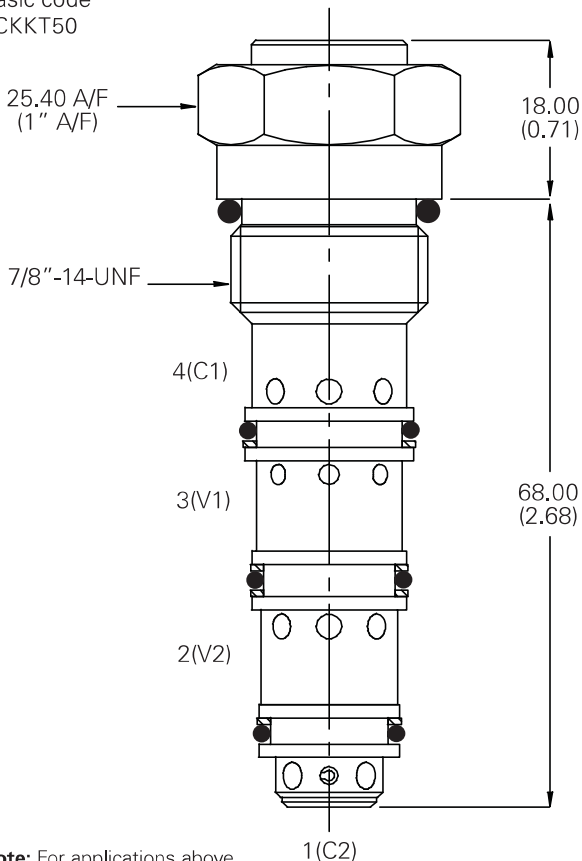

Note: For applications above 210 bar (3000 psi) please consult our technical department or use the steel body option.

Dual valve

3/8" Ports
4CKKT55 Internally Cross -Piloted

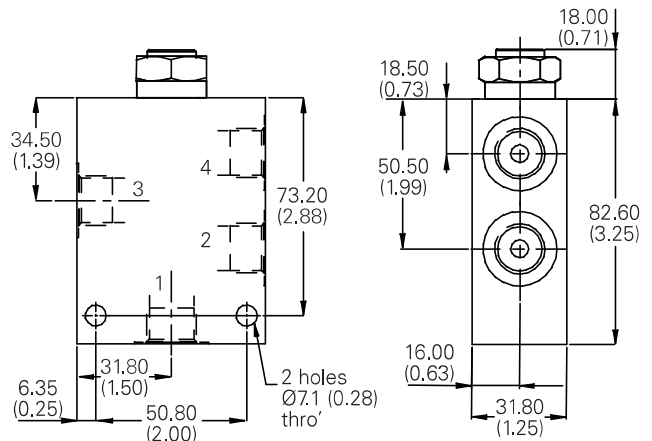

Where measurements are critical request certified drawings. We reserve the right to change specifications without notice.