

S520(H) - Solenoid valve

3-way, 2-position spool type solenoid valve
Up to 40L/min (10 USgpm) • 210 bar (3000 psi)

A

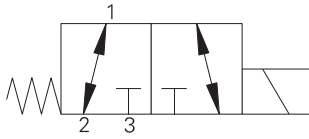

Operation

In the de-energized position this valve allows flow from port 1 to 2 while port 3 is blocked.

In the energized position flow is allowed from port 3 to port 1 while port 2 is blocked.

Features

Hardened, ground and honed working parts to limit leakage. Continuously rated. Compact design with low Pressure drop. Rated pressure on all ports.

Sectional view

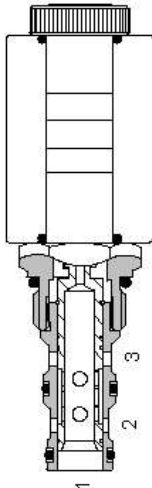

Performance data

Ratings and specifications

Figures based on Viscosity 32 cSt (150 SSU)

Actuator port location	Port 1
Max working pressure	210 bar (3000 psi)
Rated flow at $\Delta P = 5$ bar (70 psi)	Up to 40 L/min (10 USgpm)
Nominal flow	22 L/min (6 USgpm)
Internal leakage	Less than 120 ml/min past each land 210 bar differential at 32 centistokes
Temperature range	-30° to +120°C (-22° to +248°F)
Cavity	C-10-3 (see Section M)
Electrical data	See coil data sheet
Torque cartridge into cavity	30 Nm (22 lbs ft)
Mounting position	Unrestricted
Fluids	Most general purpose hydraulics fluids such as: MIL-H-5606, SAE 10, SAE 20 etc
Seal material	Standard nitrile with PTFE back up rings
Filtration	BS5540/4 Class 18/13 (25 micron or better)
Nominal viscosity range	15 to 250 cSt
Standard housing materials	Aluminium alloy
Coil weight	0.3 kg (0.6 lbs)
Cartridge weight	0.2 kg (0.4 lbs)
Seal kit	SK1030 (Nitrile) SK1030V (Viton®)
Coil part number	S520: C16-*/19 S520(H): C16-*/29
Coil voltage available	12, 24 VDC, 110, 220, VAC*

Viton is a registered trademark of E.I. DuPont

*AC coils must be used with a rectifying connector

Description

This is a 3-way 2-position, direct acting, spool type solenoid valve. This valve can be used in applications requiring separate pressure and tank lines, such as a single acting cylinder or any other application where a three way two position solenoid valve is needed.

Pressure drop

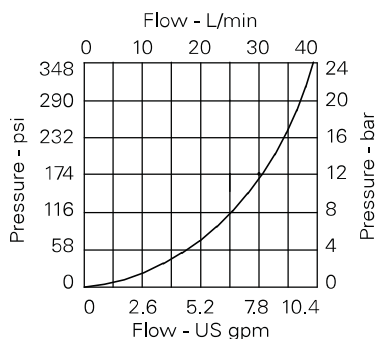

Selector Mode

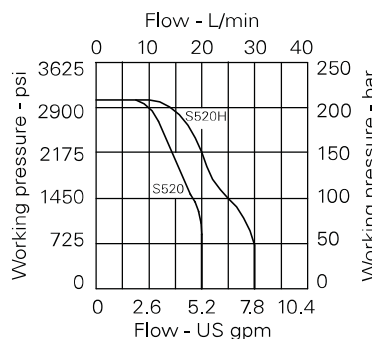

Normally closed and Normally open modes

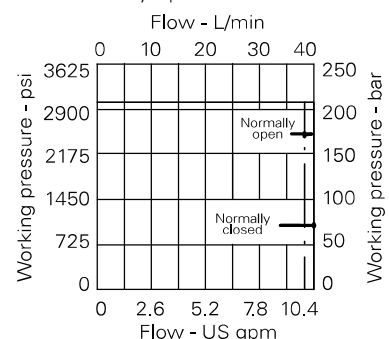

Where measurements are critical request certified drawings. We reserve the right to change specifications without notice.

S520(H) - Solenoid valve

3-way, 2-position spool type solenoid valve
Up to 40L/min (10 USgpm) • 210 bar (3000 psi)

A

Model code

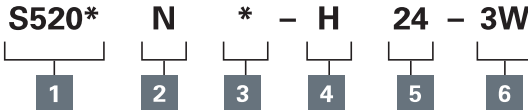

- 1 Function**
S520 - Standard valve
S520(H) - Heavy duty valve

- 2 Seal material**
N - Nitrile
V - Viton®

- 3 Manual Override**
2 - Screw
(Consult factory for availability).
See page A-960.

- 4 Coil Termination**
H - DIN43650
F - Flying leads
DM - Deutsch moulded
Other terminations available on request.

- 5 Voltage**
12 - 12 VDC
24 - 24 VDC
110 - 110 VAC
220 - 220 VAC

6 Port size

Code	Port size	Housing number - body only
Aluminium		
3W	3/8" BSP	B18982
4W	1/2" BSP	B19358
8T	1/2" SAE	B19360

Dimensions

mm (inch)

Cartridge only

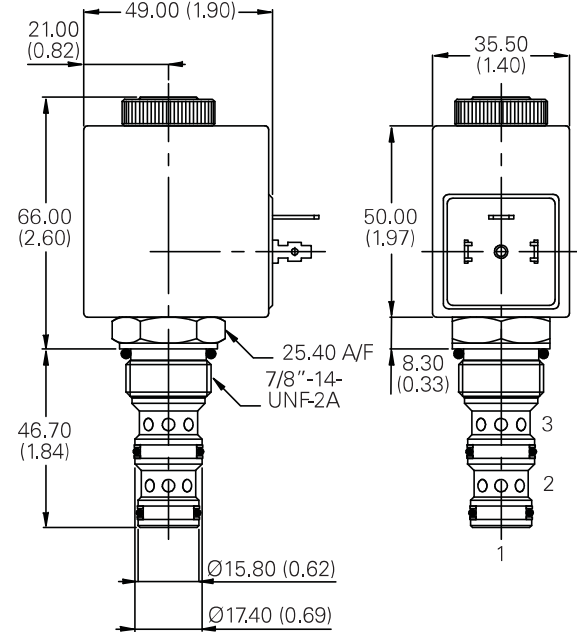

Installation drawing

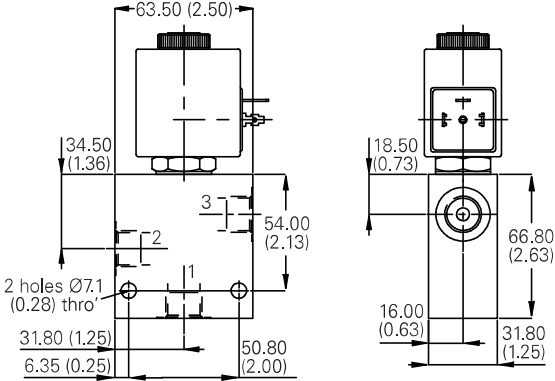

Where measurements are critical request certified drawings. We reserve the right to change specifications without notice.