

SV1-8-3/3M - Solenoid valve

3-way, 2-position spool type solenoid valve
 11 L/min (3 USgpm) • 210 bar (3000 psi)

A

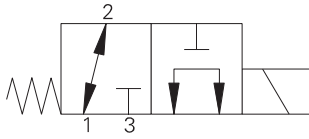

Operation

In the de-energized position this valve allows flow from port 1 to 2 while port 3 is blocked.

In the energized position flow is allowed from port 3 to port 1 while port 2 is blocked.

Features

Hardened, ground and honed working parts to limit leakage. IP69K Tough coil compatibility. Continuously rated. Compact design with low pressure drop. Rated pressure on all ports.

Sectional view

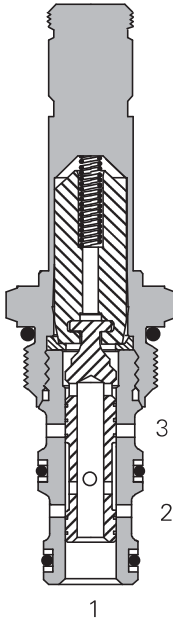

Performance data

Ratings and specifications

Performance data is typical with fluid at 21,8 cSt (105 SUS) and 49°C (120°F)

Typical application pressure (all ports)	210 bar (3000 psi)
Cartridge fatigue pressure (infinite life)	210 bar (3000 psi)
Rated flow	11 L/min (3 USgpm)
Internal leakage (per land)	82 cm ³ /min (5 in ³ /min) max @ 210 bar (3000 psi)
Temperature range	-40° to 120°C (-40° to 248°F)
Coil duty	Continuous from 85% to 110% of nominal voltage
Cavity	C-8-3
Fluids	All general purpose hydraulic fluids such as: MIL-H-5606, SAE 10, SAE 20 etc.
Filtration	Cleanliness code 18/16/13
Housing material (standard)	Aluminum
Weight including coil	0,30 kg (0,66 lbs)
Seal kit	02-160755 (Buna-N), 02-160756 (Viton®)

Viton is a registered trademark of E.I. DuPont

Description

This is a 3-way 2-position, direct acting, spool type solenoid valve. This valve can be used in applications requiring separate pressure and tank lines, such as a single acting cylinder or any other application where a three way two position solenoid valve is needed.

Pressure drop

Cartridge only

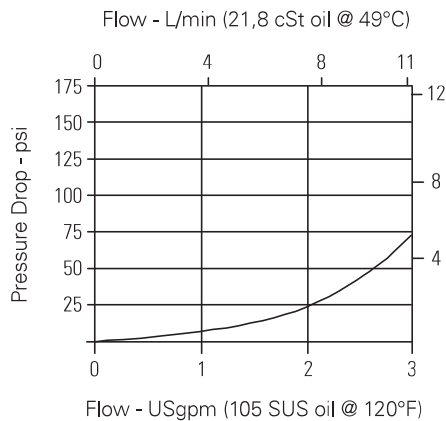

Pressure drop vs. Flow

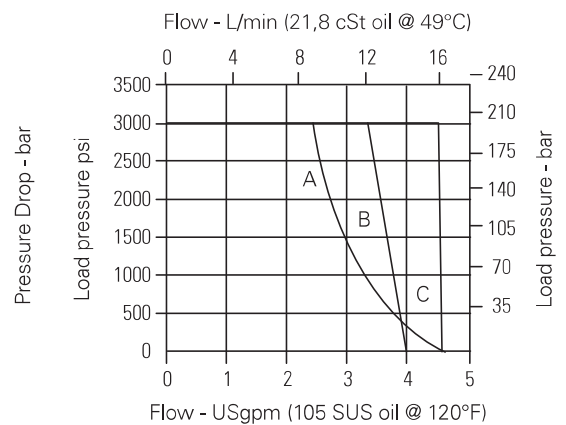

Operating Limits

- A - Selector 1 to 3
- B - Normally Open
- C - Normally closed and Selector 1 to 2

Where measurements are critical request certified drawings. We reserve the right to change specifications without notice.

SV1-8-3/3M - Solenoid valve

3-way, 2-position spool type solenoid valve
11 L/min (3 USgpm) • 210 bar (3000 psi)

Model code

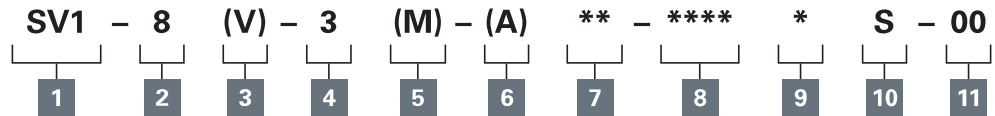

A

1 Function

SV1 - Solenoid valve

2 Size

8 - 8 size

3 Seal material

Blank - Buna-N
V - Viton®

4 Style

3 - 3-way, 2 position

5 Manual override option

Blank - No manual override
M - Knob type

For valve dimensions with manual override option installed see page A-980.

6 Valve housing material

Omit for Cartridge only
A - Aluminum

7 Port size

Code	Port size	Housing number
0	Cartridge only	
2G	1/4" BSPP	02-160739
3G	3/8" BSPP	02-160740
4T	SAE 4	02-160741
6T	SAE 6	02-160742

See section J for housing details.

8 Voltage rating

Blank - No coil	24A - 24VAC
12D - 12VDC	115A - 115VAC
24D - 24VDC	230A - 230VAC
36D - 36VDC	12B - 12VDC/w diode*
	24B - 24VDC/w diode*

*Optional arc suppression diode.

9 Connector types

Blank - No coil
G - ISO 4400 DIN 43650
Q - Spade terminals
W - Flying lead
N - Deutsch (DC only)
Y - Amp JR (DC only)
D - Metripack 150 male (DC only)
J - Metripack 280 male (DC only)

10 Coil series

S - 8 series, 20 W

For coil part numbers and dimensions see section C.

11 Special features

00 - None

(Only required if valve has special features, omitted if "00".)

Dimensions

mm (inch)

Cartridge only

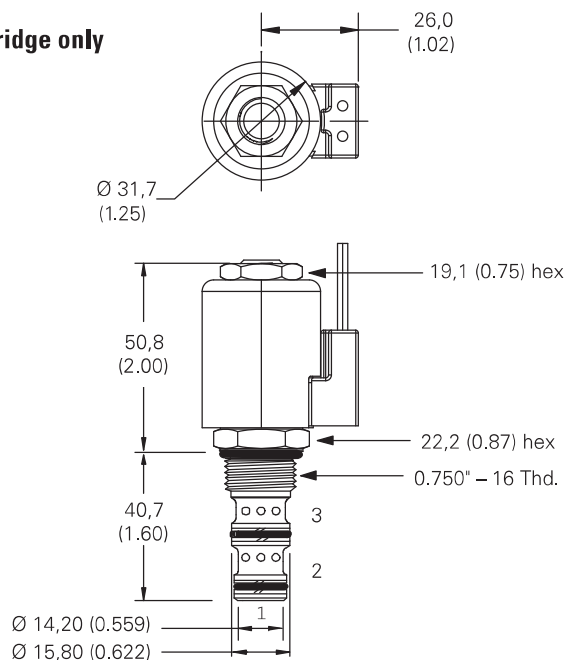

Torque cartridge in steel or aluminum housing 34-41 Nm (25-30 ft lbs)

Note: When solenoid valve is ordered as cartridge only, nut is included.

Installation drawing

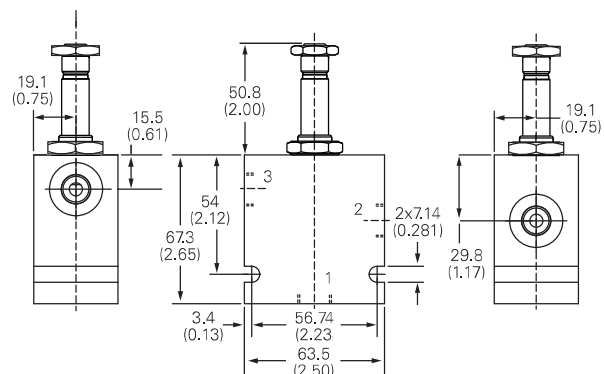

Warning

Maintain 5-8 Nm (4-6 ft lbs) maximum torque on valve tube nut.

Over tightening may cause valve failure.

Where measurements are critical request certified drawings. We reserve the right to change specifications without notice.