

# SV1 I-10-3/3M - Solenoid valve

3-way, 2-position, spool type solenoid valve  
Up to 23 L/min (6 USgpm) • 350 bar (5000 psi)

A

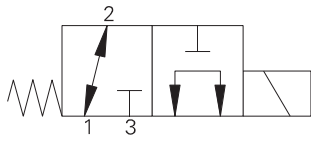

## Operation

In the de-energized position this valve allows flow from port 2 to 1 while port 3 is blocked.

In the energized position flow is allowed from port 1 to port 3 while port 2 is blocked.

## Features

Hardened, ground and honed working parts to limit leakage. IP69K Tough coil compatibility. Continuously rated. Compact design with low Pressure drop. Rated pressure on all ports. Working pressure 350 bar.

## Sectional view

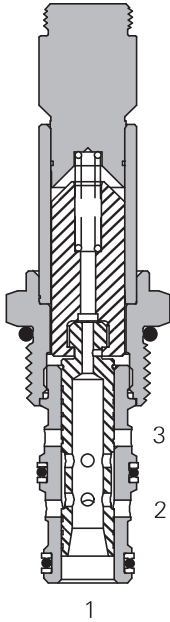

## Performance data

### Ratings and specifications

*Performance data is typical with fluid at 21,8 cSt (105 SUS) and 49° C (120° F)*

Typical Application pressure (all ports)	350 bar (5000 psi)
Cartridge fatigue pressure (infinite life)	310 bar (4500 psi)
Rated Flow	23L/min (6 USgpm)
Internal leakage, port 2 to port 1	164 cm <sup>3</sup> /min (10 in <sup>3</sup> /min) max at 350 bar (5000 psi)
Temperature range	-40° to 100° C (-40° to 212° F)
Coil Duty	Continuous from 85% to 110% of nominal voltage
Cavity	C-10-3
Fluids	All general purpose hydraulics fluids such as: MIL-H-5606, SAE 10, SAE 20, etc.
Filtration	Cleanliness code 18/16/13
Housing material (standard)	Steel
Weight Cartridge only	0,19 kg (0.42 lbs)
Seal kit	889624 (Buna-N) 889628 (Viton®)

Viton is a registered trademark of E.I. DuPont

## Description

This is a 3-way 2-position, high pressure, direct acting, spool type solenoid valve. This valve can be used in applications requiring separate pressure and tank lines, such as a single acting cylinder or any other application where a three way two position solenoid valve is needed.

## Pressure drop

Cartridge only

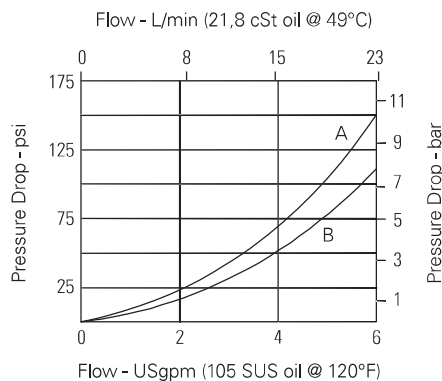

### Pressure drop vs. Flow

- A** - Port 3 to port 1
- B** - Port 1 to port 2

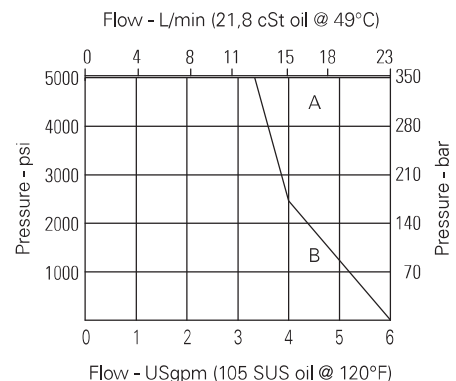

### Operating limits

- A** - Normally open, normally closed
- B** - Selector 1 to 2

Where measurements are critical request certified drawings. We reserve the right to change specifications without notice.

# SV11-10-3/3M - Solenoid valve

3-way, 2-position, spool type solenoid valve  
Up to 23 L/min (6 USgpm) • 350 bar (5000 psi)

## Model code

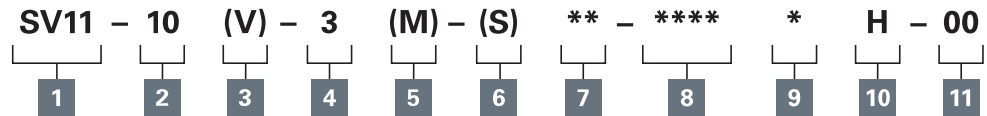

A

### 1 Function

SV11 - Solenoid valve

### 2 Size

10 - 10 size

### 3 Seal material

Blank - Buna-N

V - Viton®

### 4 Style

3 - 3 way, 2 position

### 5 Manual override option

Blank - No manual override

M - Manual override

For valve dimensions with Manual override option installed see page A-980.

### 6 Valve housing material

Blank - Cartridge only

S - Steel

### 7 Port size

Code	Port size	Housing number
0	Cartridge only	
2G	1/4" BSPP	02-175127
3G	3/8" BSPP	02-175128
6T	SAE 6	02-175124
8T	SAE 8	02-175125

See section J for housing details.

### 8 Voltage rating

00 - No coil

12D - 12VDC

24D - 24VDC

36D - 36VDC

24A - 24VAC

115A - 115VAC

230A - 230VAC

12B - 12VDC/w diode\*

24B - 24VDC/w diode\*

\*Optional arc suppression diode

### 9 Connector types

Blank - No coil

G - ISO 440 DIN 43650

Q - Spade terminals

W - Flying lead

N - Deutsch (DC only)

Y - Amp JR (DC only)

D - Metripack 150 male (DC only)

J - Metripack 280 male (DC only)

### 10 Coil series

H - 10 series, 29 W

For coil dimensions see section C.

### 11 Special features

00 - None

(Only required if valve has Special features, omitted if "00".)

## Dimensions

mm (inch)

Torque cartridge in steel housing 68-75 Nm (50-55 ft. lbs)

**Note:** For applications above 210 bar please consult our technical department or use the steel body option.

### Cartridge only

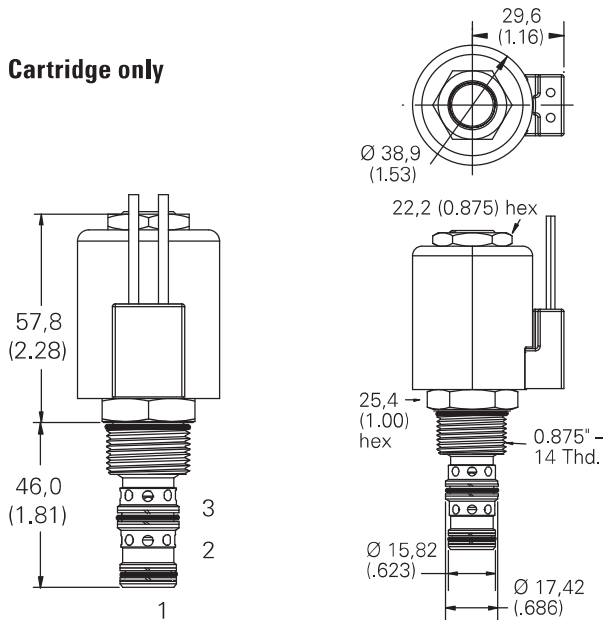

### Installation drawing

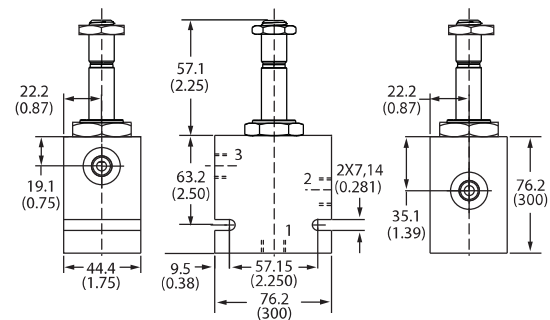

### Warning

Maintain 5-8 Nm (4-6 ft. lbs) maximum torque on valve tube nut. Over tightening may cause valve failure.

Where measurements are critical request certified drawings. We reserve the right to change specifications without notice.